

LANZETTE

Typ R

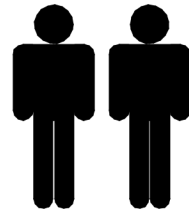

90 min

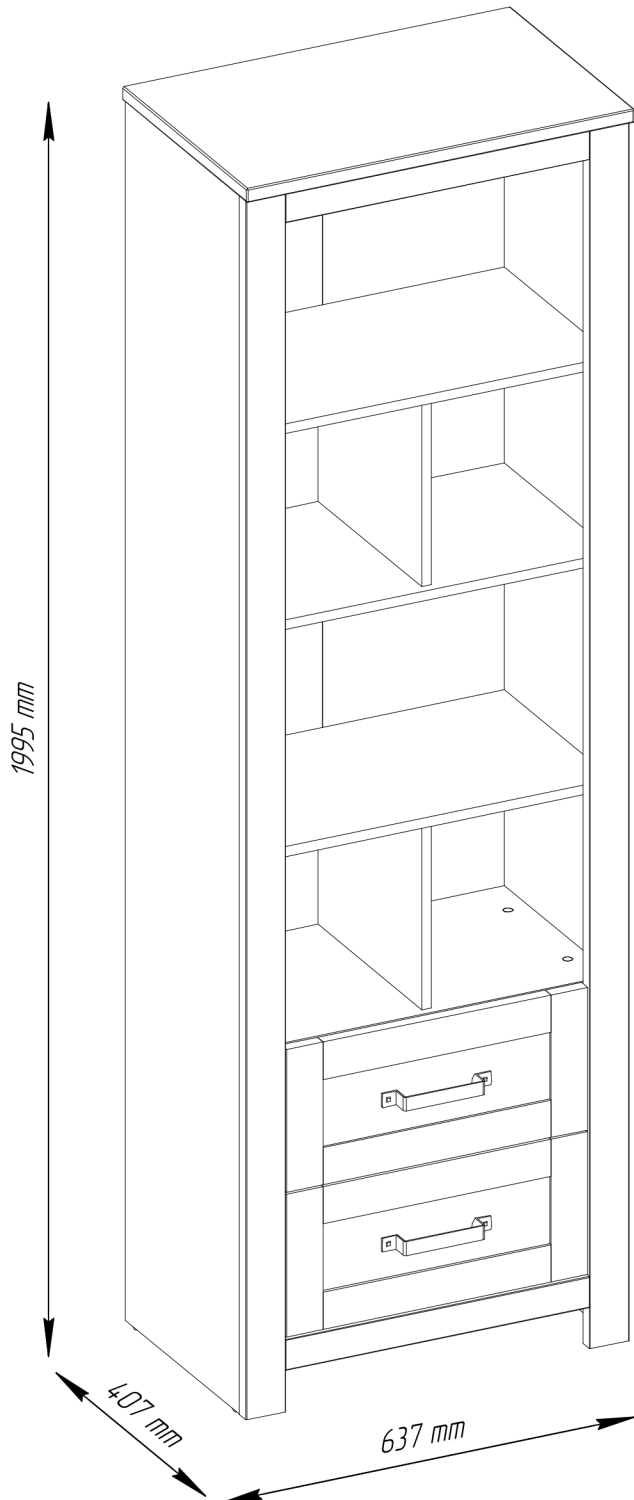

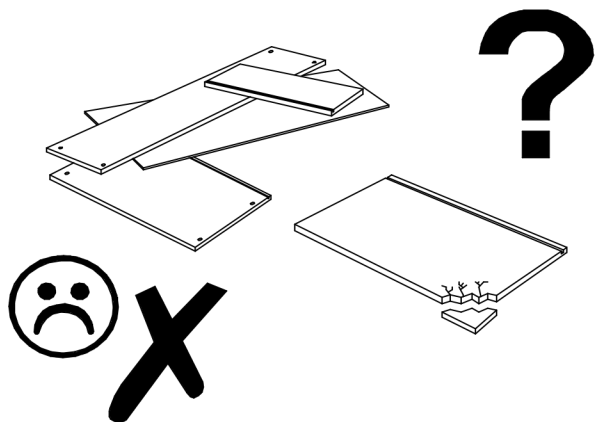
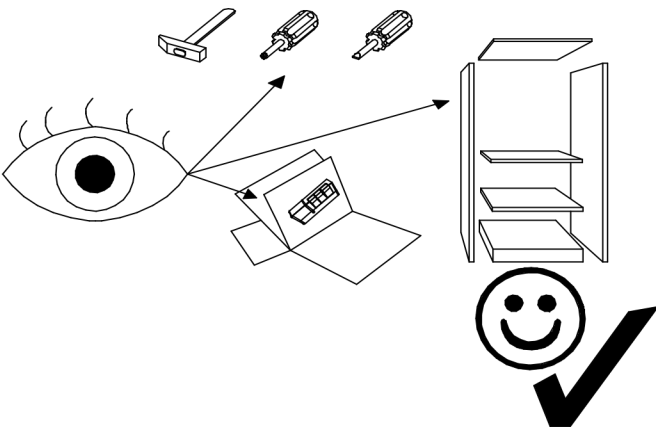
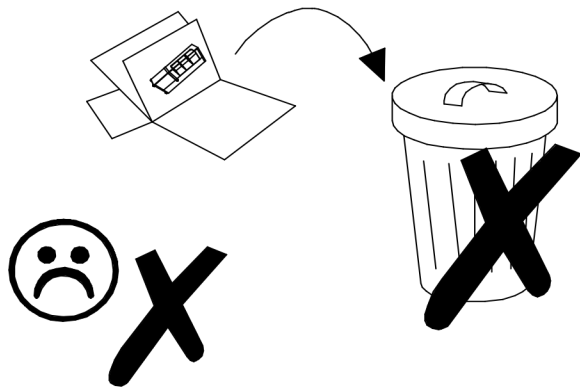
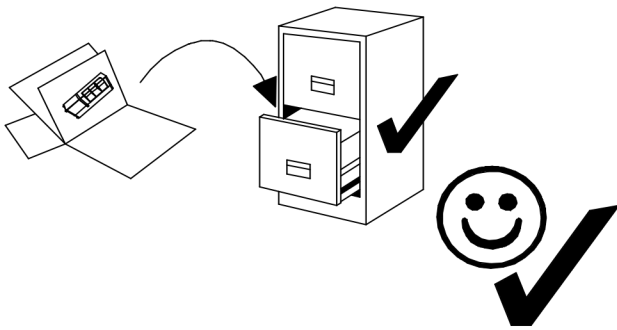
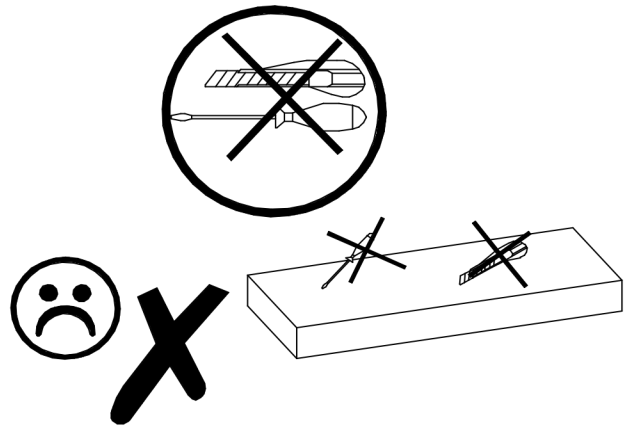
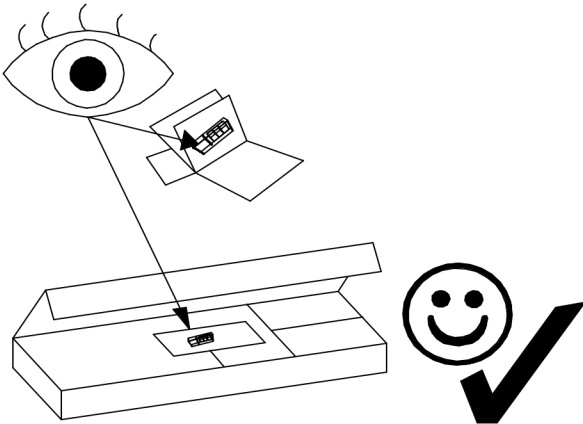

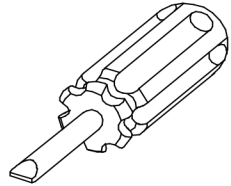
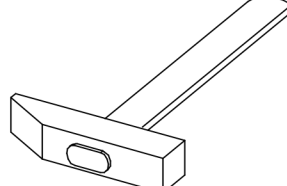
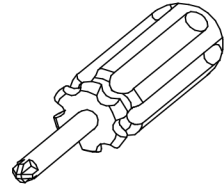
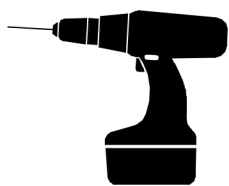
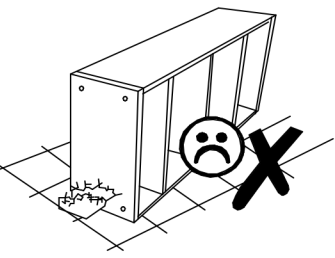
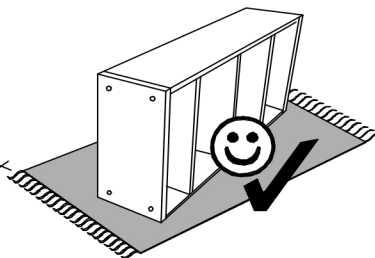
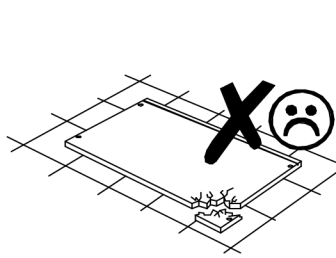
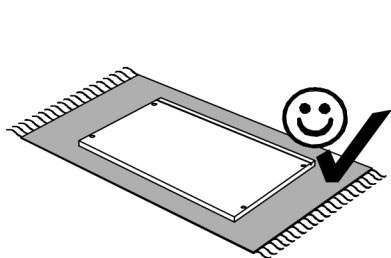
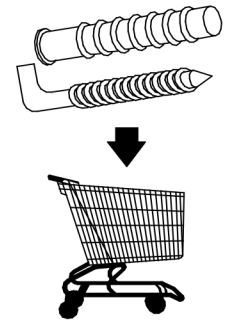
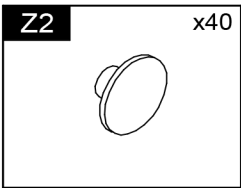
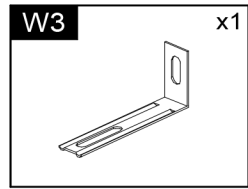
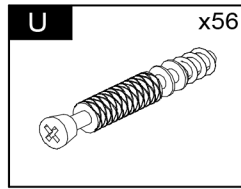
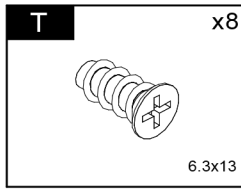
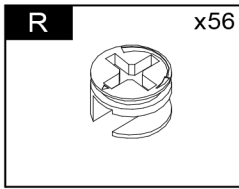
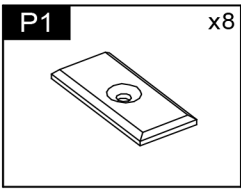
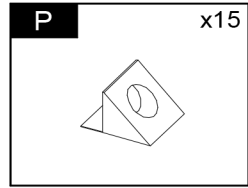
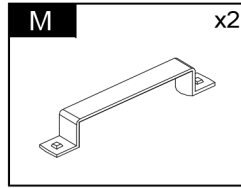
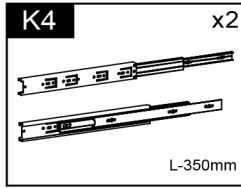
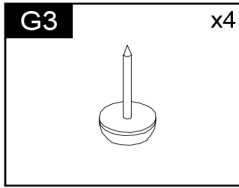
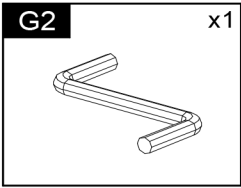
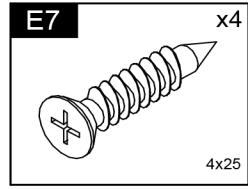
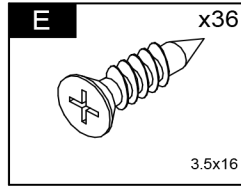
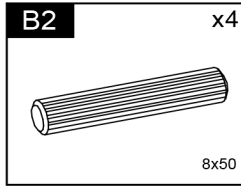
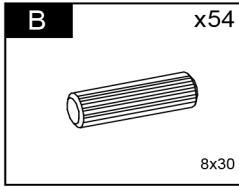
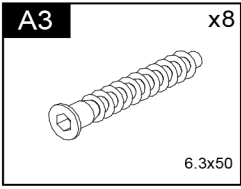
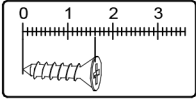

Element symbol	Measurements				Code	Paket
1	637	407	22	1	1002	2/2
2	1968	375	16	1	1003	1/2
3	1968	375	16	1	1004	1/2
4	597	70	16	1	1005	2/2
5	597	70	16	1	1025	2/2
6	452.5	354.5	16	1	1026	1/2
7	452.5	354.5	16	1	1027	1/2
8	597	355	16	1	1007	1/2
9	597	355	16	2	1038	1/2
10	597	355	16	1	1039	1/2

11	300	340	16	2	1041	1/2
12	350	160	16	2	1029	1/2
13	432.5	160	16	2	1030	1/2
14	350	160	16	2	1031	1/2
15	446.5	346	3	2	N/A	2/2
16	1875	610	3	1	N/A	1/2
17	495	230	19	2	3001	2/2
18	1968	65	22	1	3002	1/2
19	1968	65	22	1	3003	1/2
20	500	50	22	1	3004	2/2
21	500	50	22	1	3005	2/2

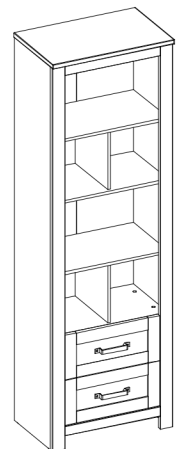
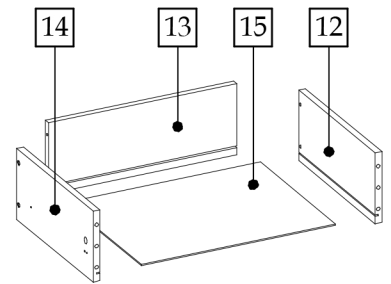
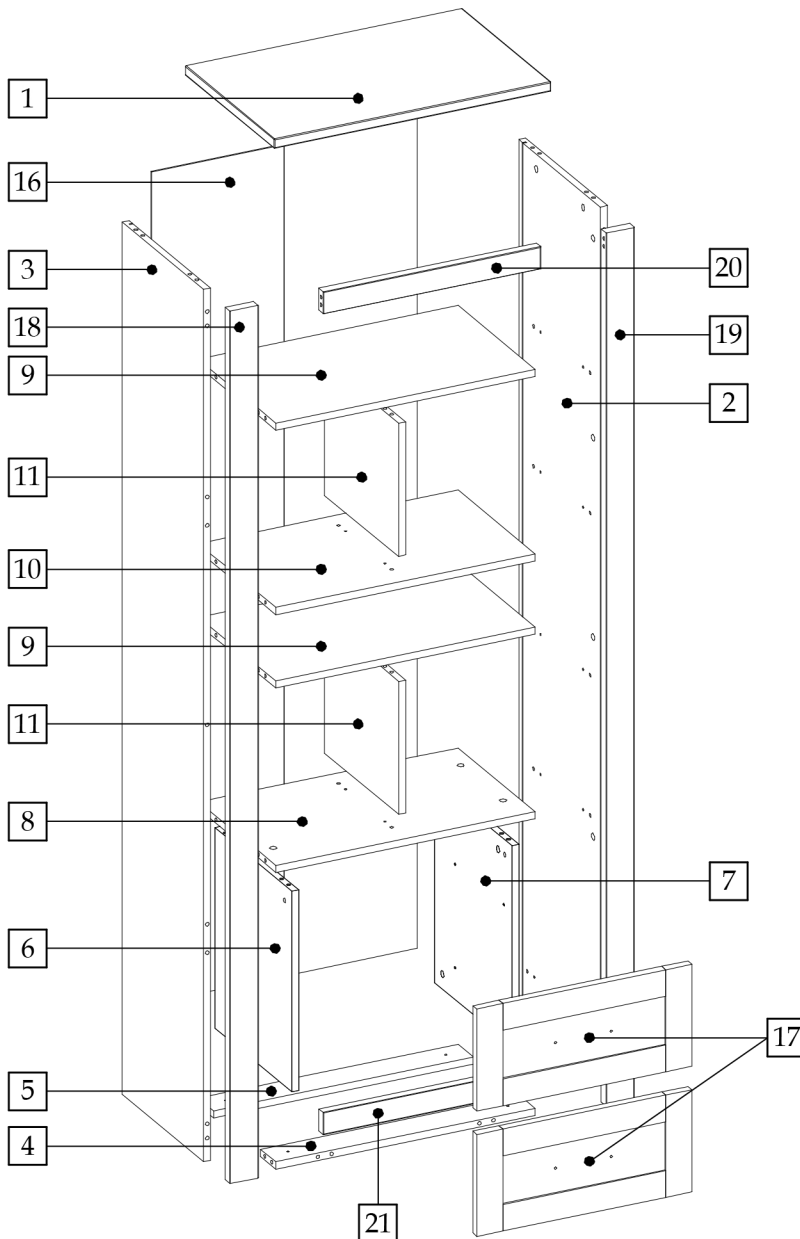

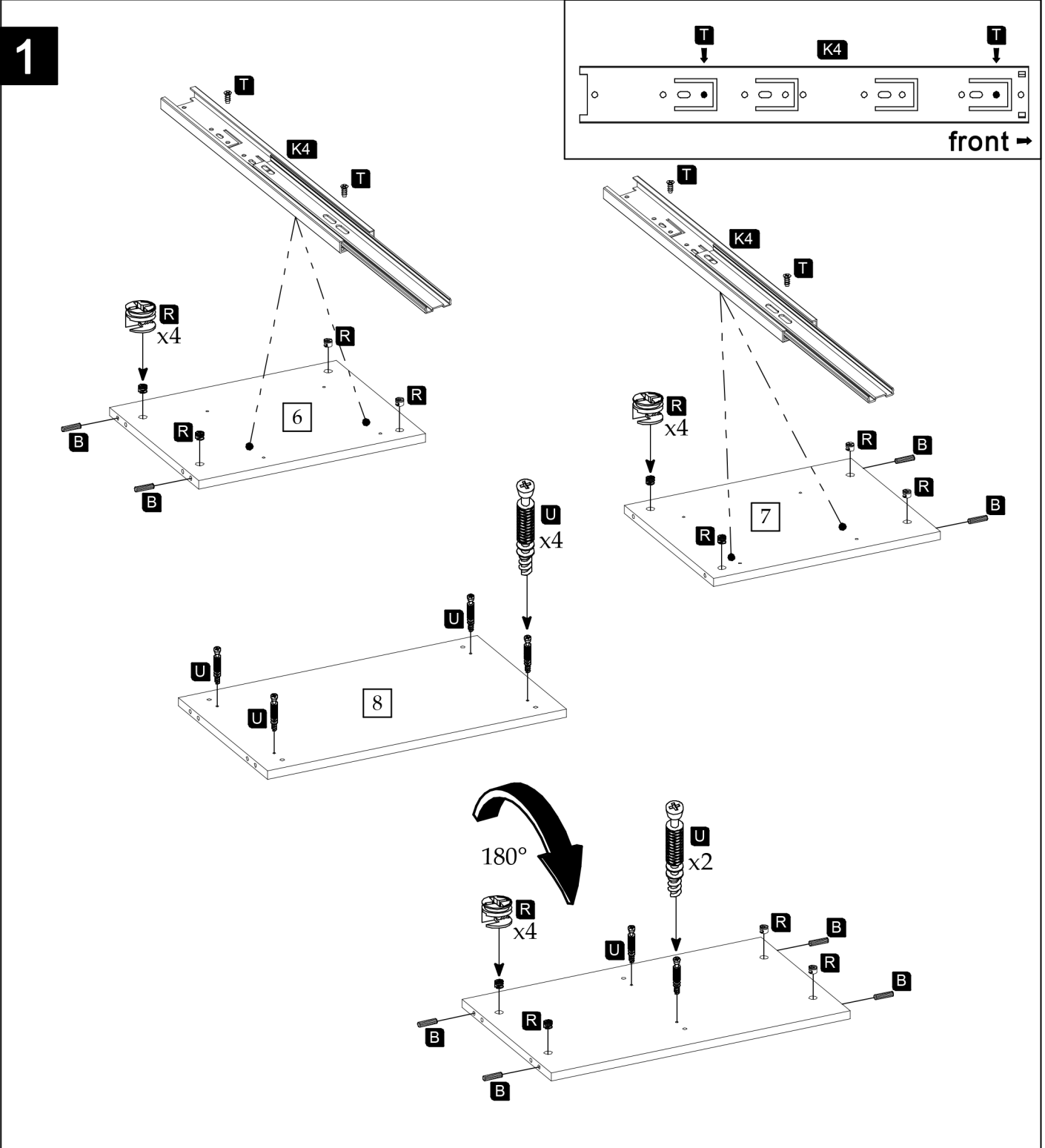
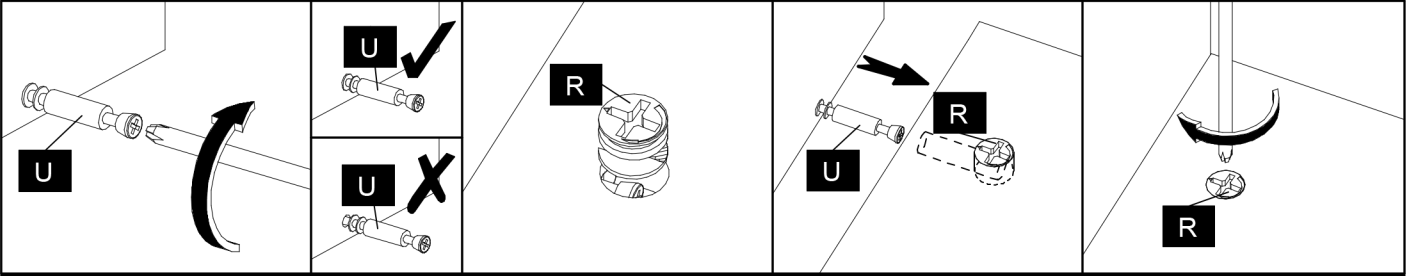

2

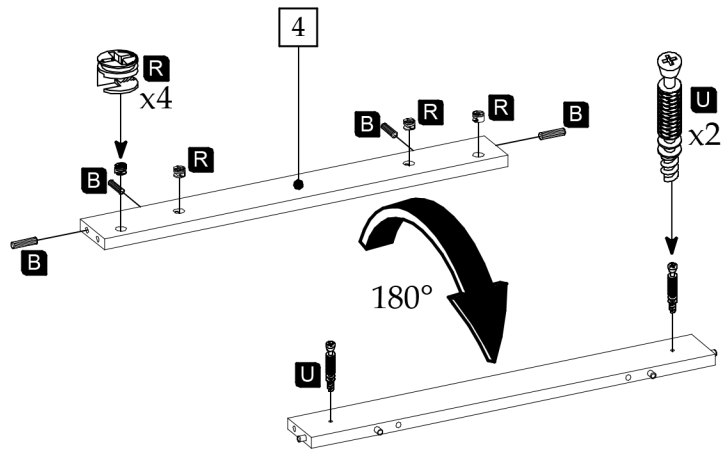
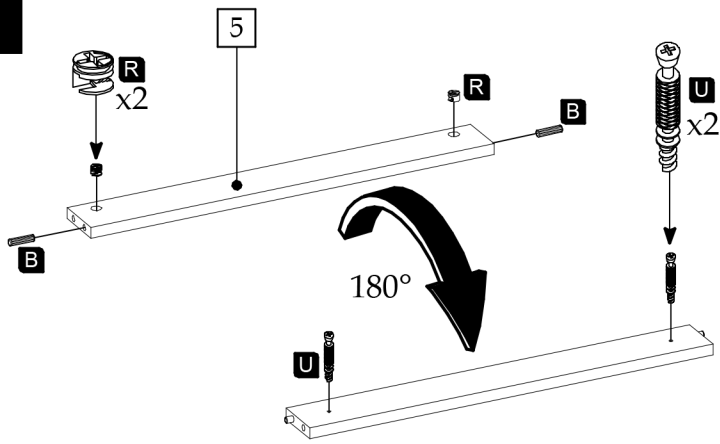

3

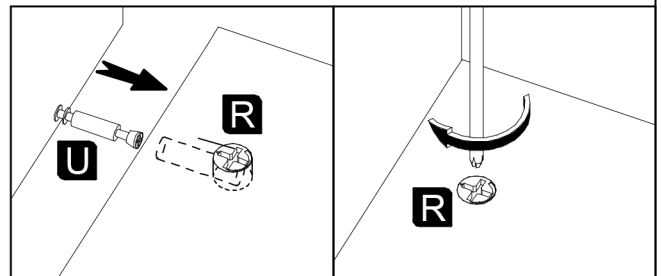
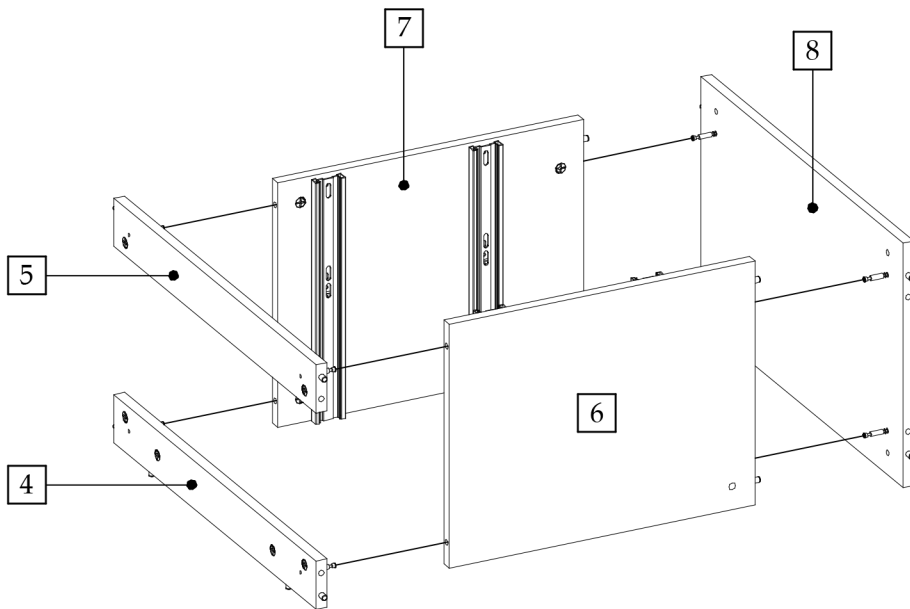

4

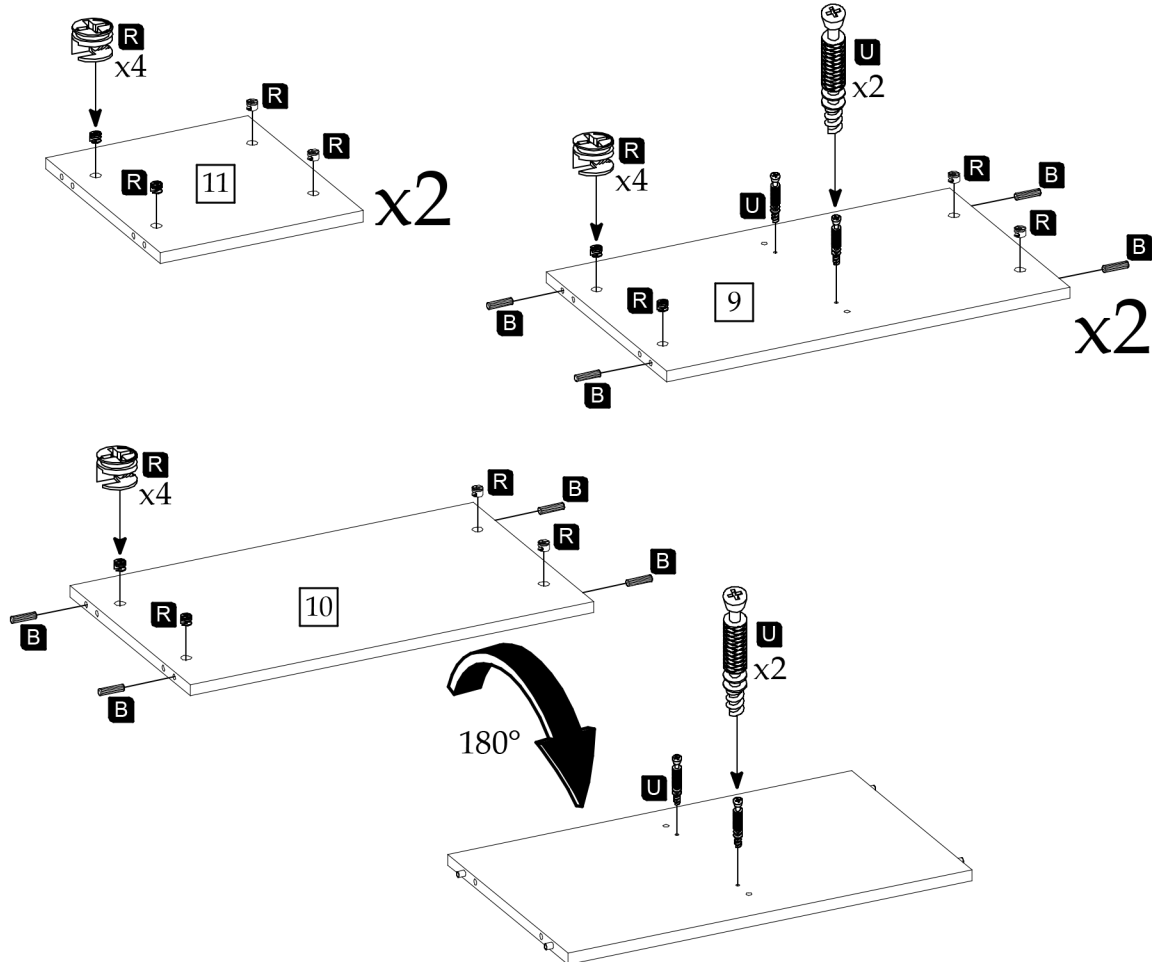

5

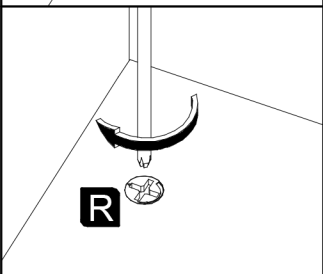
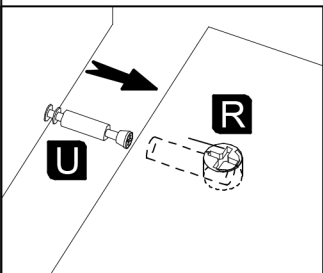
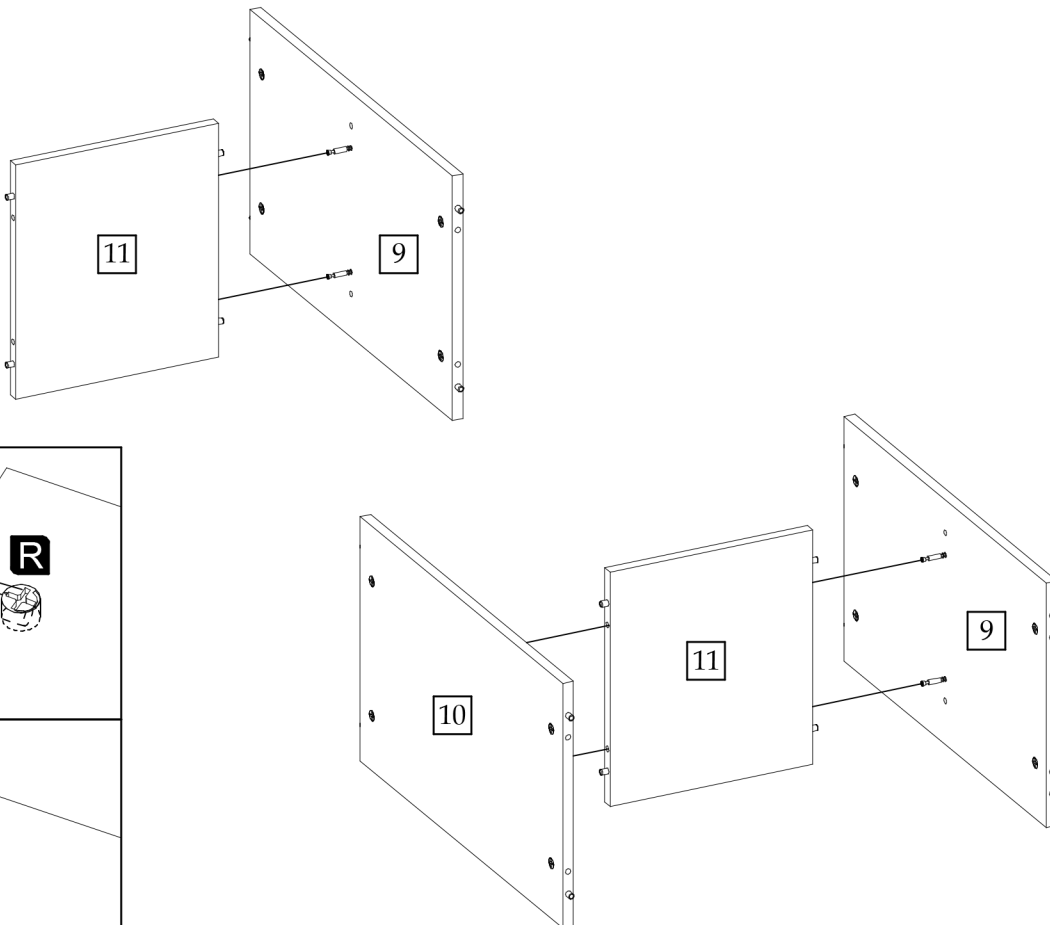

6

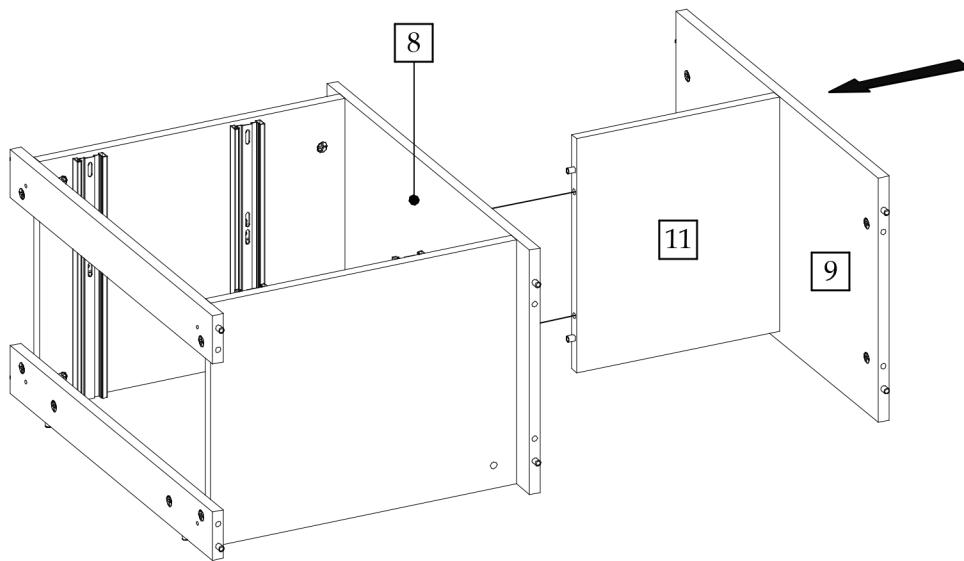

7

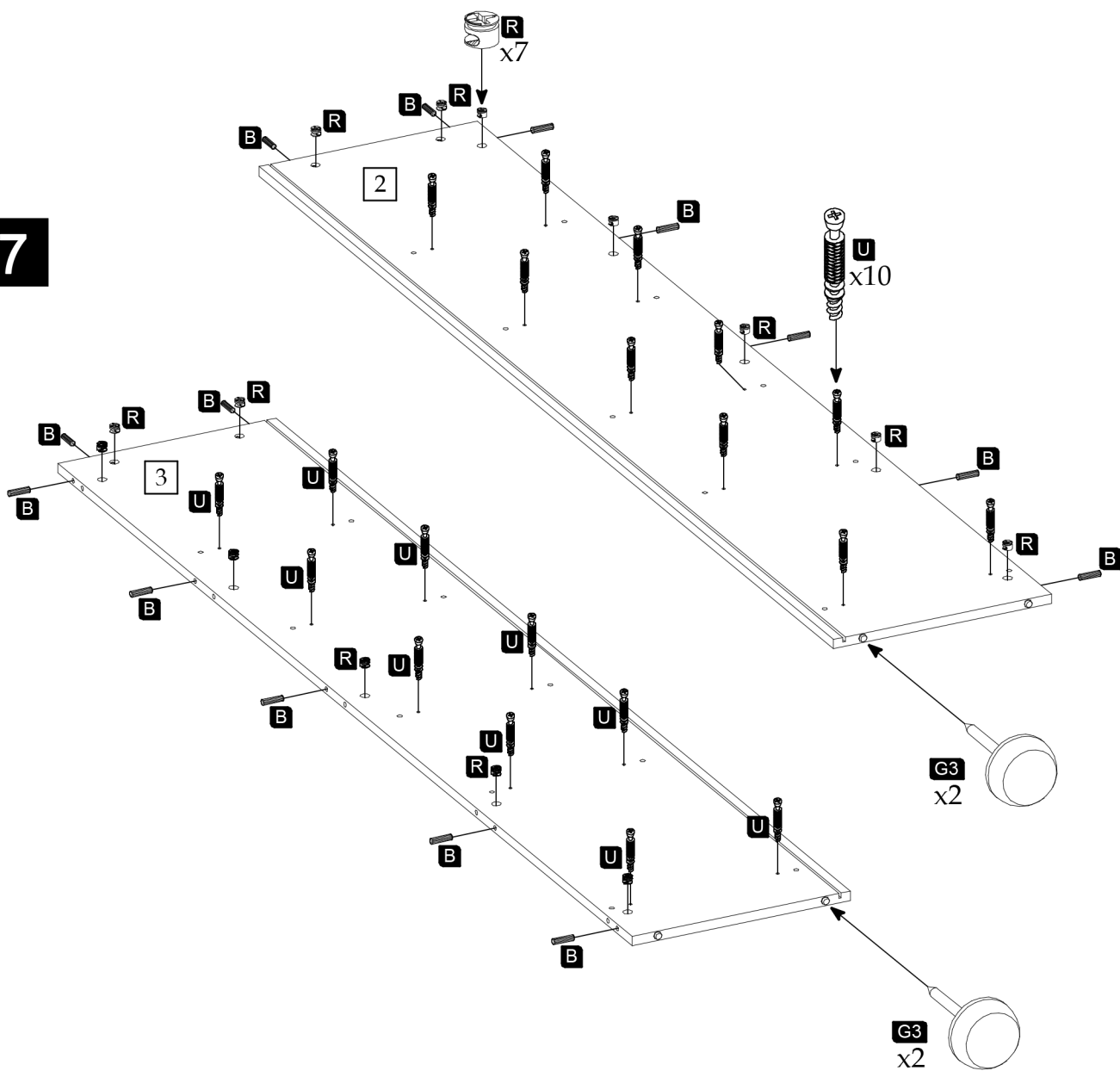

8

LANZETTE R

8

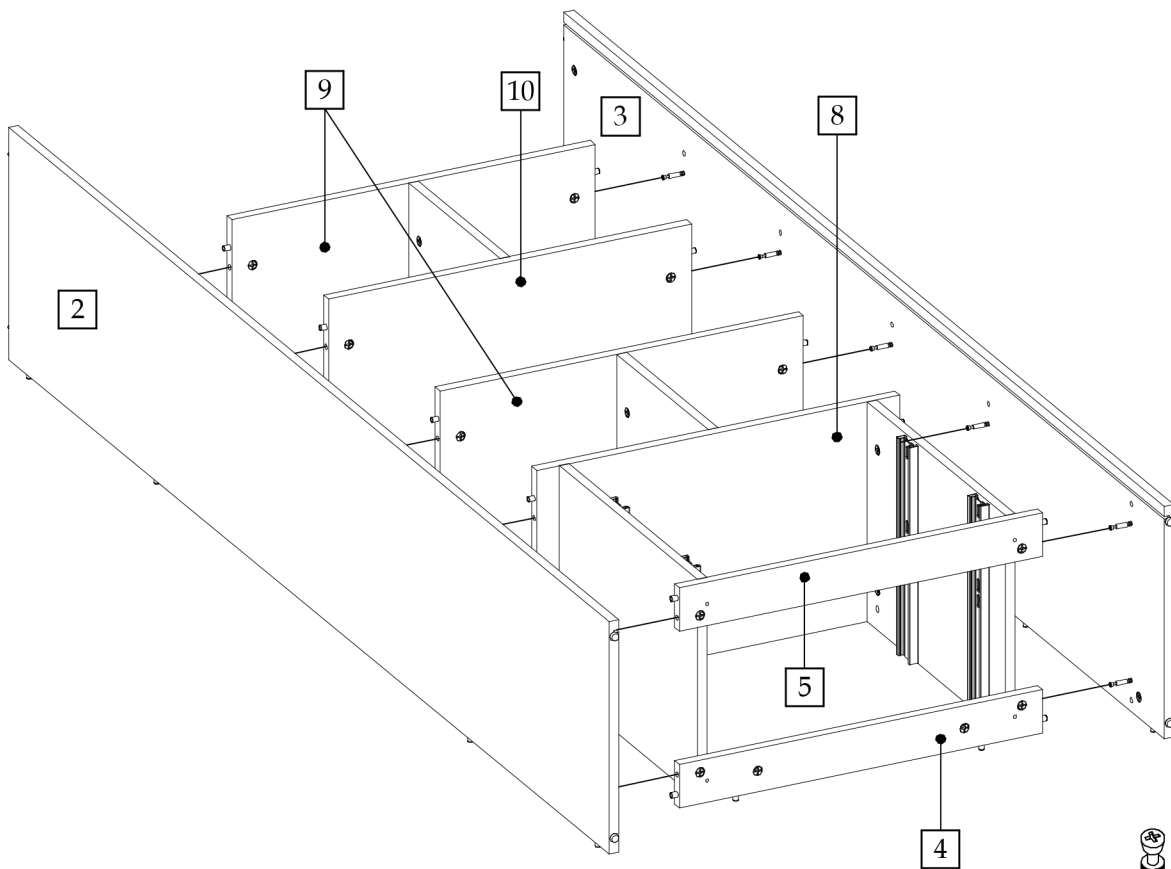

9

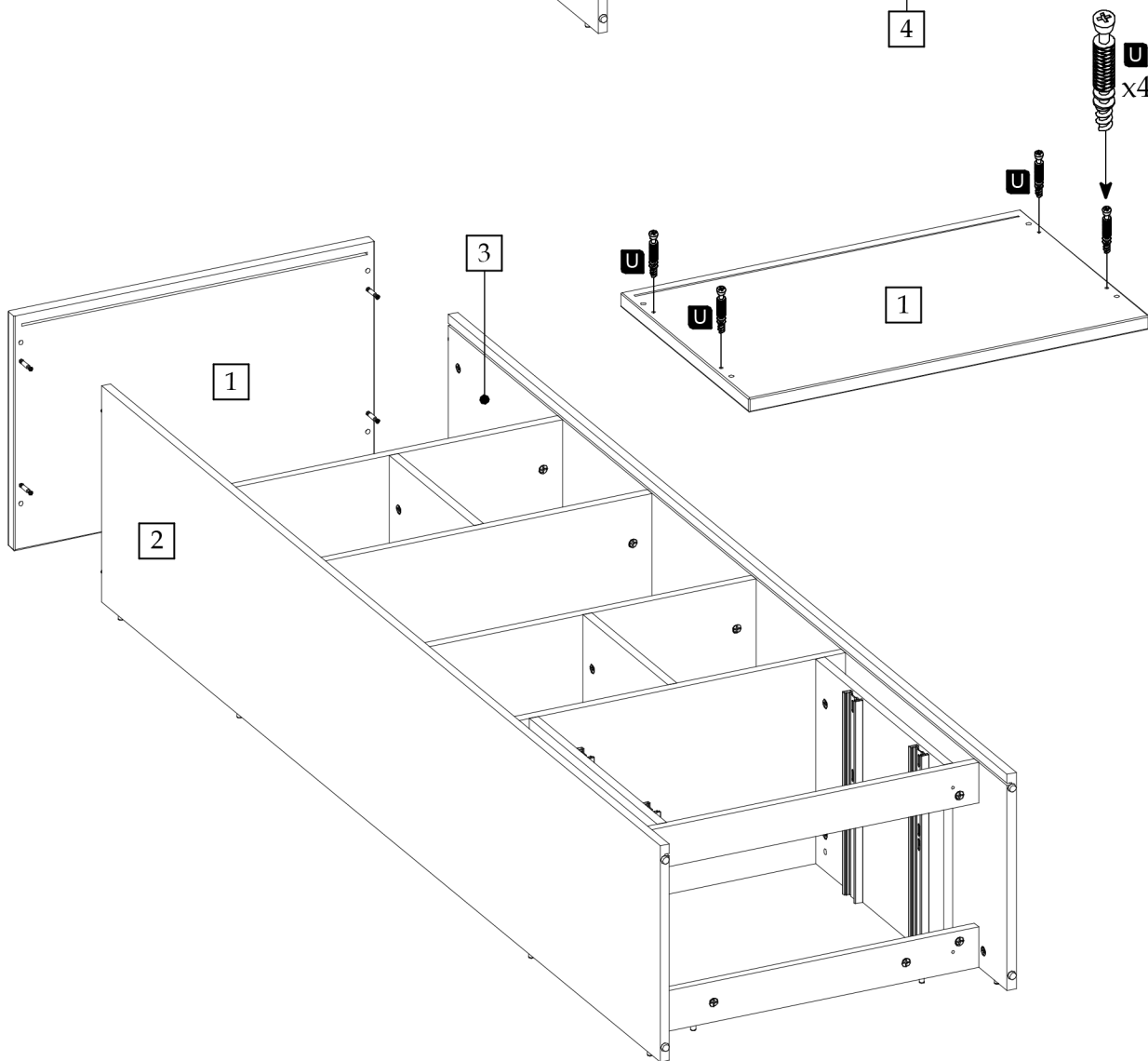

10

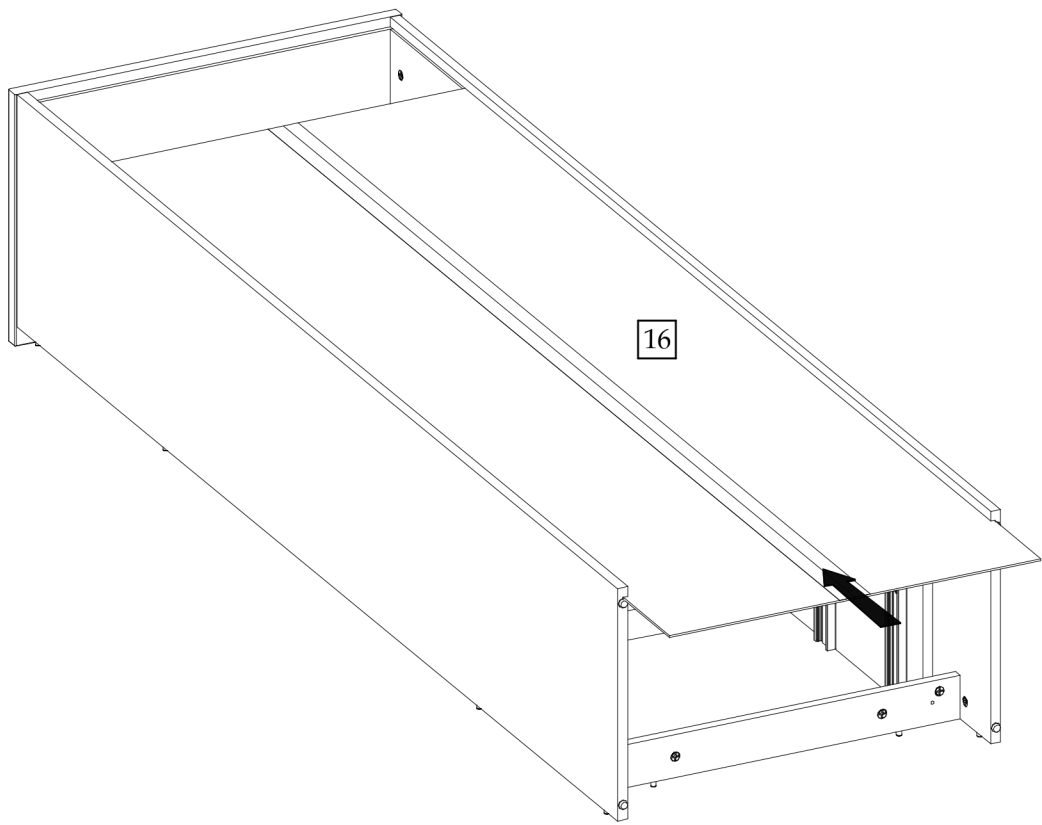

11

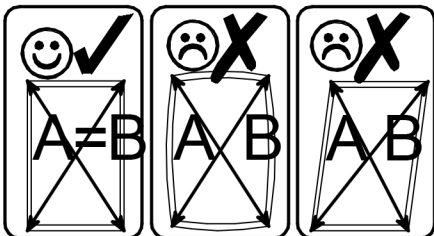
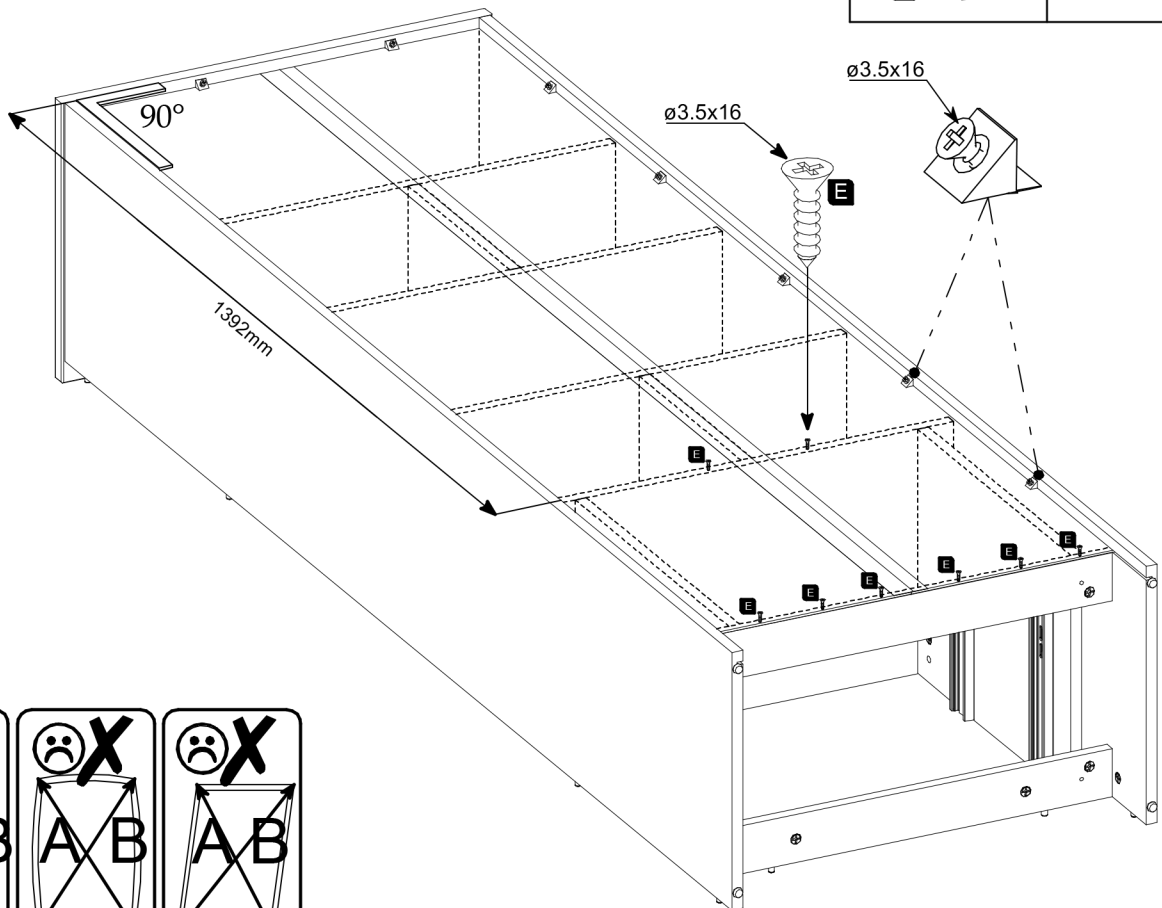

13

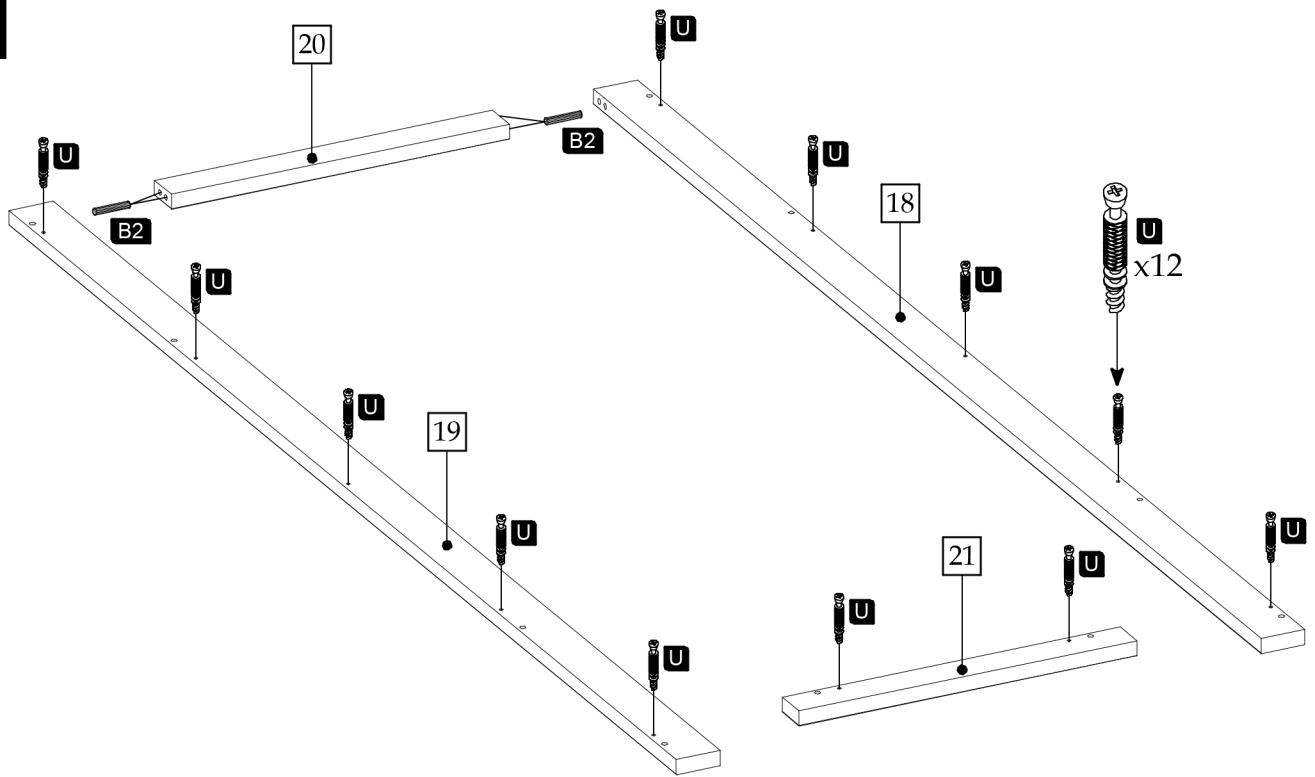

14

